



**Elektro**  
GENESIS



**GYNECOLOGY/OBSTETRICS  
INSTRUMENTS Catalogue**



**BUSCH**  
Umbilical Cord  
Scissors

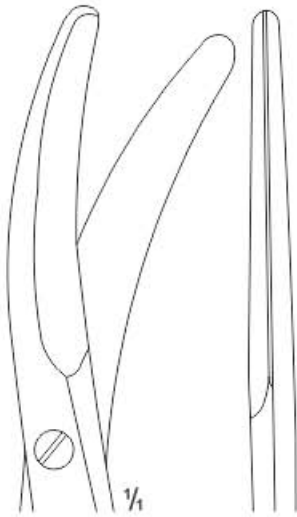

**G-001** Straight  
**G-002** Curved to side  
5" (13cm)



**AMERICAN**  
Umbilical Cord  
Scissors

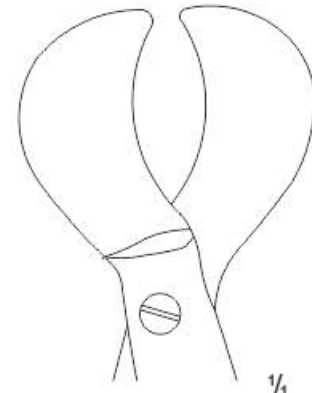

**G-003**  
4.25" (10.5cm)



**DUBOIS**  
Scissors

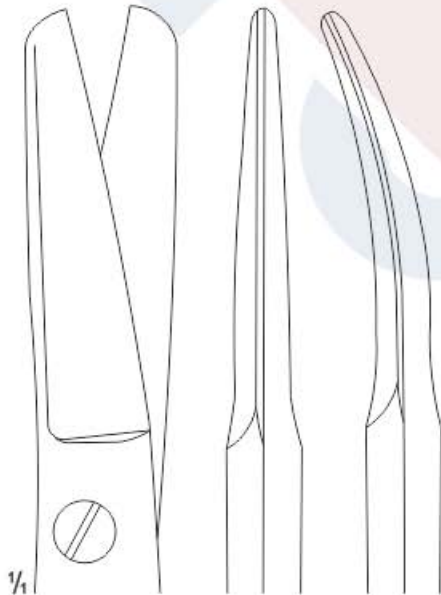

**G-004** Straight  
**G-005** Curved  
10.5" (27cm)



**FERGUSON**  
Uterine Scissors



**G-006** 6.5" (16.5cm)  
**G-007** 7" (18cm)  
**G-008** 8.25" (21cm)  
Angled



# UTERINE & EPISIOTOMY SCISSORS



**SIMS**  
Uterine Scissors



**G-009** Straight  
**G-010** Curved  
9" (23cm) Blunt/Blunt



**UTERINE**  
Scissors

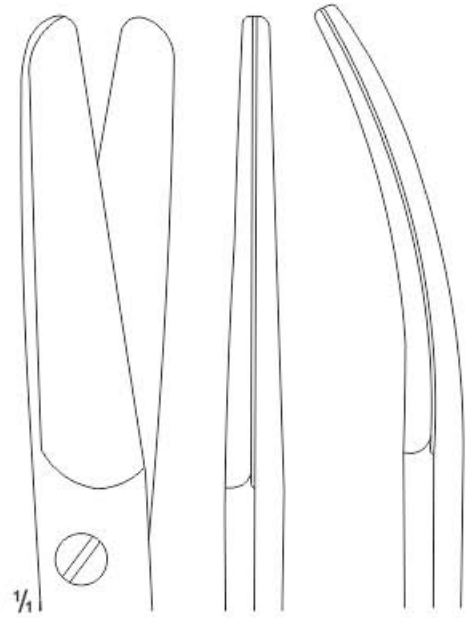

**G-011** Straight  
**G-012** Curved  
9" (23cm) Blunt/Blunt



**LAWSON TAIT**  
Episiotomy scissors

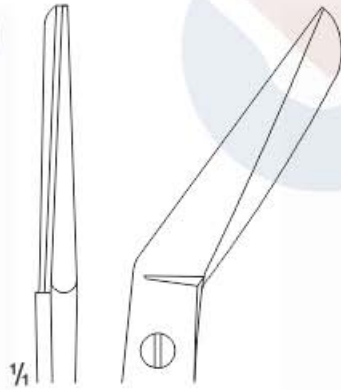

**G-013**  
5.5" (14cm)



**BRAUN STADLER**  
Episiotomy scissors



**G-014**  
5.5" (14cm)

**G-015**  
8.75" (22cm)



**G-016**  
6" (15.5cm)

**COMYN BERKELEY**  
Vulva Self Retaining



**DOYEN**  
Supra Hollow Handle  
**G-017** 3" x 11" (7.5cm x 28cm)  
**G-018** 3.5" x 11" (9cm x 28cm)  
**G-019** 4" x 11" (10cm x 28cm)  
**G-020** 4.5" x 11" (11.5cm x 28cm)



**DOYEN POZZI**  
Retractor  
**G-021** 1 3/4" x 2" x 10"  
(4.5cm x 5cm x 25.5cm)  
**G-022** 1 3/4" x 3 1/2" x 10"  
(4.5cm x 9cm x 25.5cm)  
**G-023** 1 3/4" x 4 1/2" x 10"  
(4.5cm x 11.5cm x 25.5cm)



**G-024**  
8" (20cm)

**GELPI**  
Vulva Self Retaining



**DOYEN**  
Vaginal Flat Retractor  
**G-025** 1 1/8" x 4" x 9"  
(1.75cm x 10cm x 23cm)



**JOLL** Thyroid Self Retaining  
**G-026** 6" (15.5cm)



# RETRACTORS

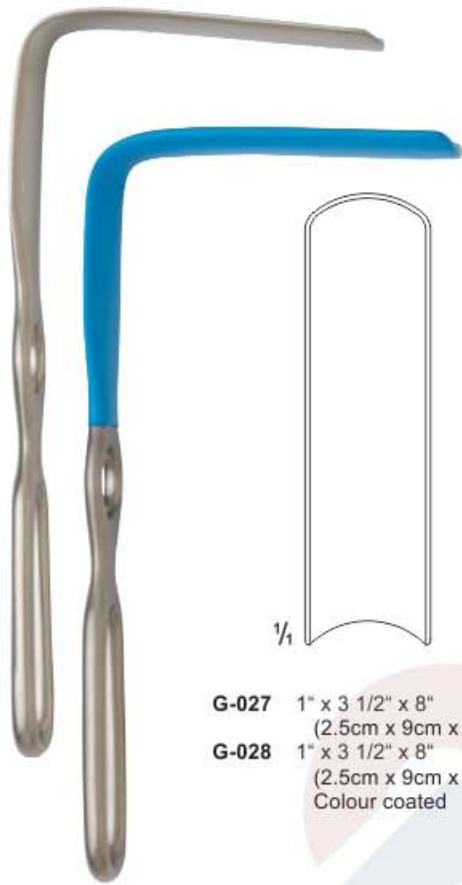

**G-027** 1" x 3 1/2" x 8"  
(2.5cm x 9cm x 20cm)

**G-028** 1" x 3 1/2" x 8"  
(2.5cm x 9cm x 20cm)  
Colour coated

**LANDON**  
Vaginal Retractor



**G-029**  
1 1/2" x 3 3/4" x 10 3/4"  
(3cm x 9.5cm x 27.5cm)

**WERTHEIM**  
Retractor

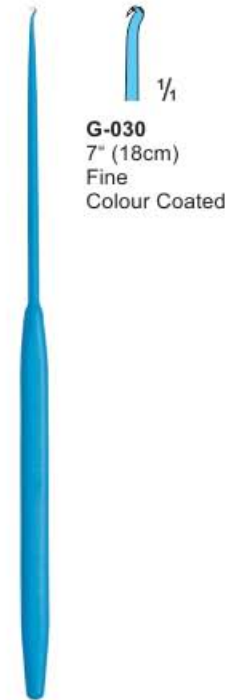

**G-030**  
7" (18cm)  
Fine  
Colour Coated

**IRIS**  
Skin Hooks



**G-031**  
10" (25.5cm)  
Fine  
Colour Coated

**IRIS**  
Skin Hooks



**G-032**  
9" (23cm)  
\*bic\*

**TENACULUM EMETT**

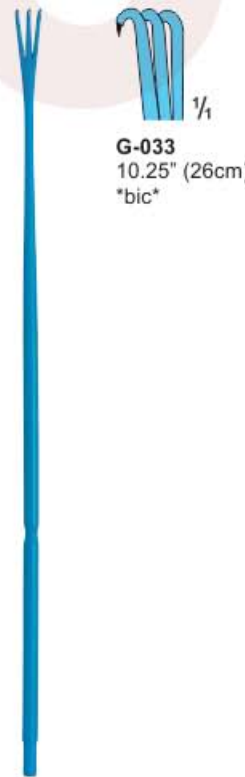

**G-033**  
10.25" (26cm)  
\*bic\*

**TENACULUM 3 PRONG**

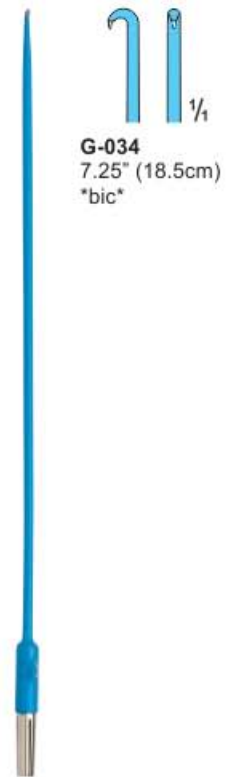

**G-034**  
7.25" (18.5cm)  
\*bic\*

**WHITTAKER**



NEEDLE EXTENSIONS

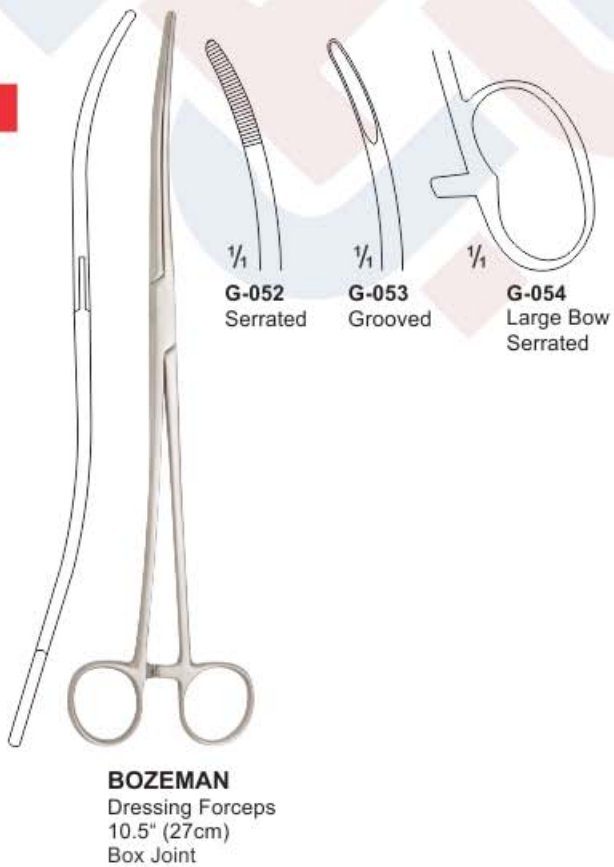



## SPECULUMS

### AUVARD Speculaums



**G-057**  
38mm x 105 mm  
Large Fixed weight



**G-058**  
38mm x 105 mm  
Large Fixed weight  
Colour Coated



**G-059**  
38mm x 105 mm  
Small Loose weight

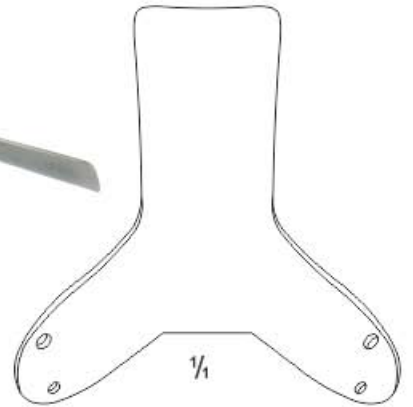

- G-060** 38mm x 75 mm  
Small Fixed weight
- G-061** 38mm x 105 mm  
Large Fixed weight
- G-062** 38mm x 105 mm  
Large Fixed weight  
Colour Coated
- G-063** 38mm x 75 mm  
Small Loose weight
- G-064** 38mm x 105 mm  
Small Loose weight



- COLLIN**  
Speculaums
- G-065** 30mm x 85mm  
Small
  - G-066** 35mm x 100mm  
Medium
  - G-067** 40mm x 110mm  
Large



- CUSCO**  
Virgin Speculaums
- G-068** 15mm x 65mm
  - G-069** 15mm x 85mm
  - G-070** 25mm x 80mm, Small
  - G-071** 30mm x 90mm, Medium
  - G-072** 30mm x 115mm, Medium
  - G-073** 35mm x 95mm, Large

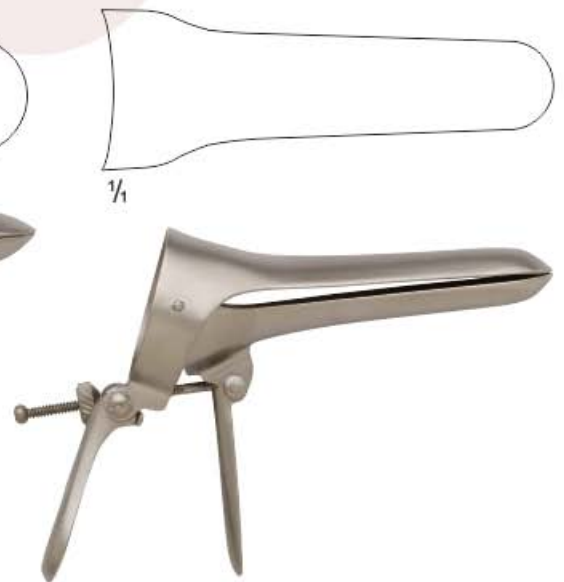

- CUSCO**  
Virgin Speculaums
- G-074** 17mm x 75mm Side Screw
  - G-075** 22mm x 80mm Small Side Screw
  - G-076** 25mm x 100mm Medium Side Screw
  - G-077** 27mm x 105mm Large Side Screw





**CUSCO**

Virgin Speculaums  
Laser black

- G-078** 15mm x 65mm
- G-079** 25mm x 80mm, Small
- G-080** 30mm x 90mm, Medium
- G-081** 35mm x 95mm, Large



**GRAVES (Brewer)**

Virgin Speculaums

- G-082** 20mm x 75mm, Small
- G-083** 35mm x 95mm, Medium
- G-084** 35mm x 115mm, Large



**GRAVES**

Virgin Speculaums  
Color Coated, Straight

- G-085** 20mm x 75mm, Small
- G-086** 35mm x 95mm, Medium
- G-087** 35mm x 115mm, Large



**GRAVES WIDE**

Virgin Speculaums  
Color Coated, Straight

- G-088** 33mm x 105mm, Medium
- G-089** 34mm x 115mm, Large





## SPECULUMS



**Graves Vaginal Speculum Leep / Lietz**  
G-090 Small  
G-091 Medium  
G-092 Large  
G-093 X-large



**Pederson Vaginal Speculum Leep / Lietz**  
G-094 Small  
G-095 Medium  
G-096 Large  
G-097 X-Large



**WEISMAN**  
Virgin Speculaums  
Color Coated  
G-098 35mm x 100mm, Left Open  
G-099 35mm x 115mm, Right Open



**PEDERSON**  
Virgin Speculaums  
Color Coated  
G-100 17mm x 100mm, Narrow  
G-101 13mm x 75mm, Small  
G-102 22mm x 100mm, Medium  
G-103 25mm x 120mm, Large



1/4

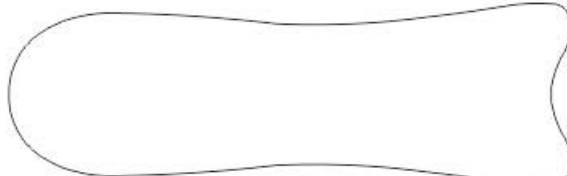

1/4



**GRAVES WIDE**

Virgin Speculaums  
Wide Pattern

**G-104** 33mm x 105mm, Medium

**G-105** 34mm x 115mm, Large

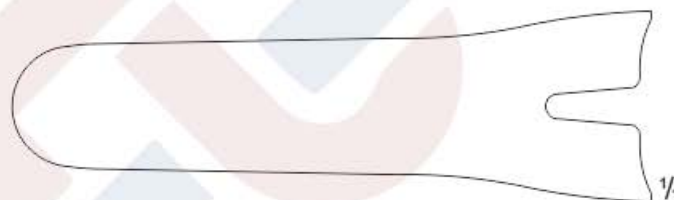

1/4



**PEDERSON**

Virgin Speculaums

**G-108** 17mm x 100mm, Narrow

**G-109** 13mm x 75mm, Small

**G-110** 22mm x 100mm, Medium

**G-111** 25mm x 120mm, Large

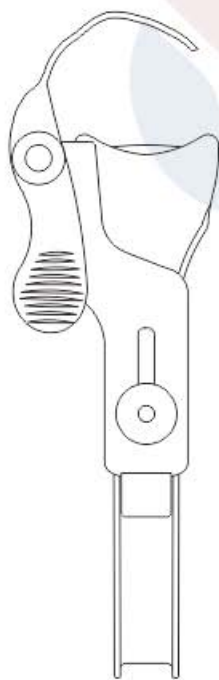
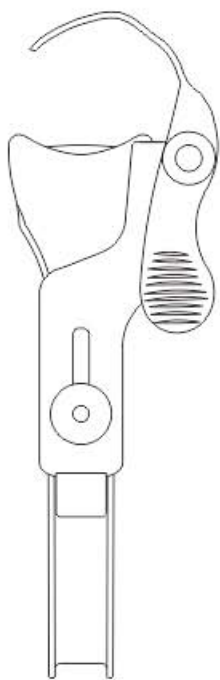

**WEISMAN GRAVES**

Virgin Speculaums

**G-106** 35mm x 115mm

Left Open

**WEISMAN GRAVES**

Virgin Speculaums

**G-107** 35mm x 115mm

Right Open



# SPECULUMS

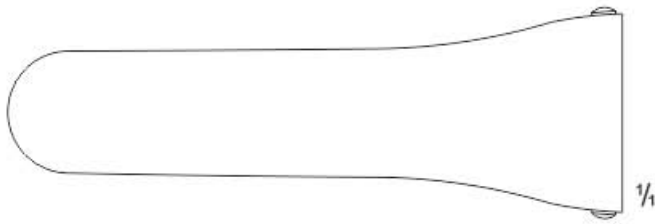

**WINTERTON**  
Vaginal Speculaums  
**G-112**  
23mm x 115mm

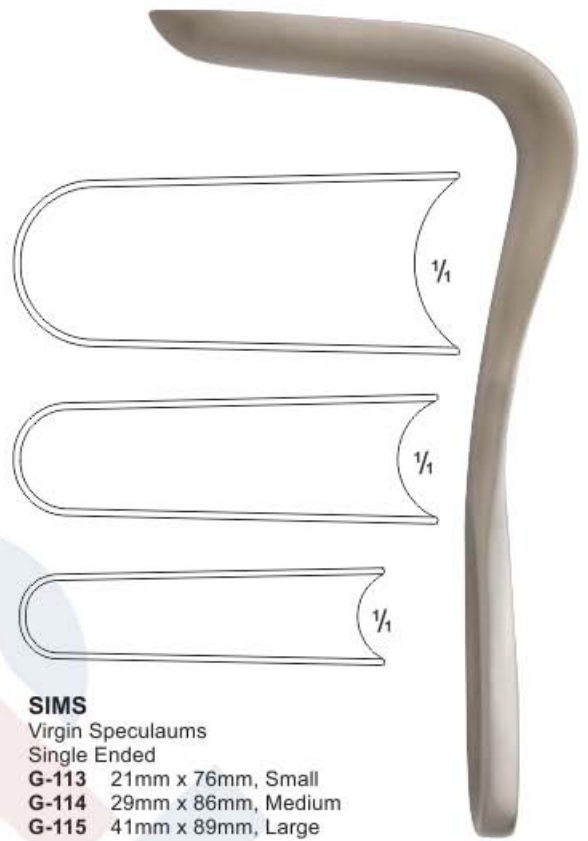

**SIMS**  
Virgin Speculaums  
Single Ended  
**G-113** 21mm x 76mm, Small  
**G-114** 29mm x 86mm, Medium  
**G-115** 41mm x 89mm, Large



**SIMS**  
Virgin Speculaums  
Single Ended, Colour Coated  
**G-116** 21mm x 76mm, Small  
**G-117** 29mm x 86mm, Medium  
**G-118** 41mm x 89mm, Large

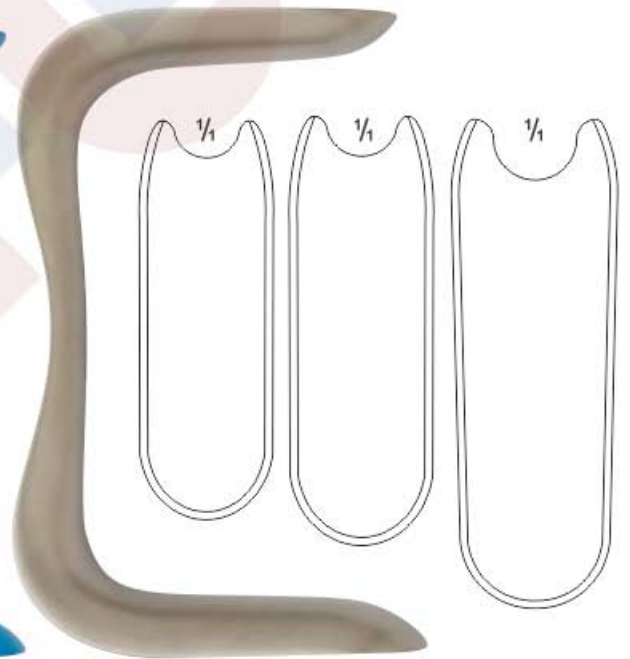

**SIMS**  
Virgin Speculaums  
Double Ended, Colour Coated  
**G-119** 26mm x 70mm, Small  
30mm x 75mm  
**G-120** 30mm x 75mm, Medium  
35mm x 80mm  
**G-121** 36mm x 80mm, Large  
40mm x 90mm

**SIMS**  
Virgin Speculaums  
Double Ended, Colour Coated  
**G-122** 26mm x 70mm, Small  
30mm x 75mm  
**G-123** 30mm x 75mm, Medium  
35mm x 80mm  
**G-124** 36mm x 80mm, Large  
40mm x 90mm



**VAGINAL**  
Lateral Wall  
Retractor  
**G-125**  
9.75" (25cm)  
Wall retraction  
Max. 2

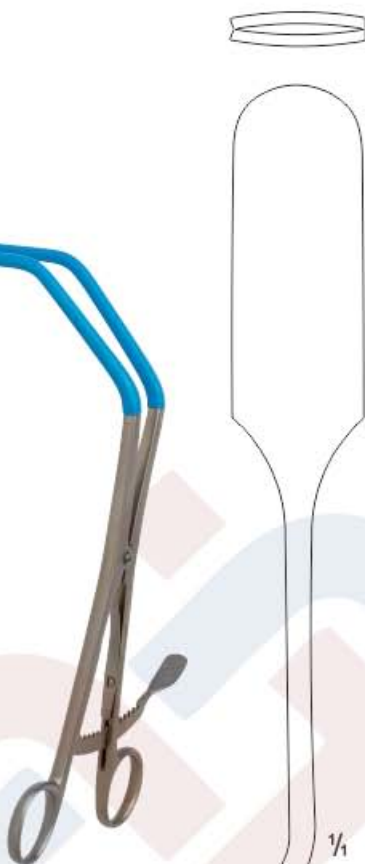

**VAGINAL**  
Lateral Wall  
Retractor  
**G-126**  
9.75" (25cm)  
Wall retraction  
Max. 2



**VAGINAL**  
Lateral Wall  
Retractor  
**G-127**  
9.75" (25cm)  
Wall retraction  
Max. 3



**VAGINAL**  
Lateral Wall  
Retractor  
**G-128**  
9.75" (25cm)  
Wall retraction  
Max. 3





## BIOPSY FORCEPS



**BURKE BIOPSY FORCEPS**  
G-129  
8.5" (21.5cm) Shaft

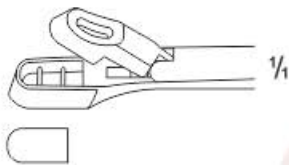

**EPPENDORF BIOPSY FORCEPS**  
G-130  
8" (20cm) Shaft



**KEVORKIAN YOUNG BIOPSY FORCEPS**  
G-131  
10" (25.5cm) Shaft



**LEECHWILKINSON BIOPSY FORCEPS**  
G-132  
8" (20cm) Shaft Round



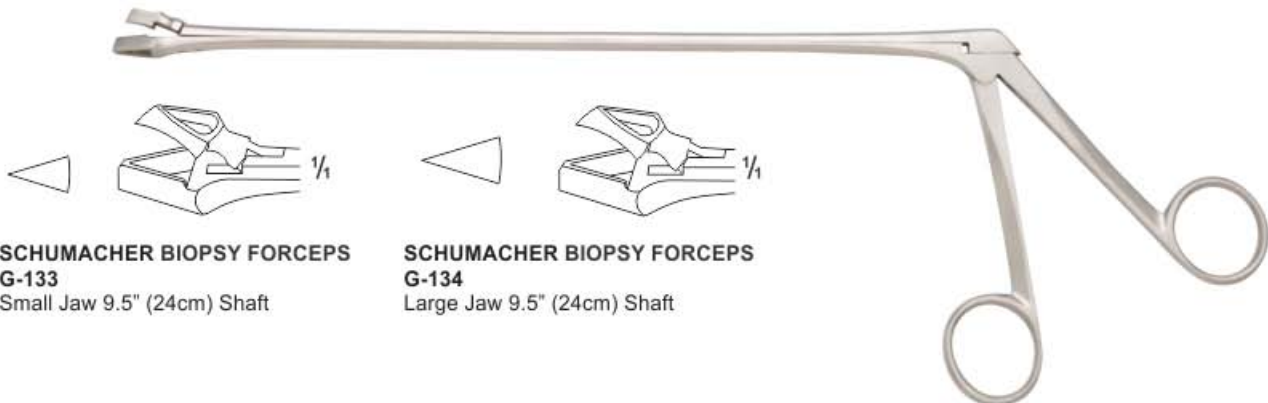

**SCHUMACHER BIOPSY FORCEPS**  
**G-133**  
 Small Jaw 9.5" (24cm) Shaft

**SCHUMACHER BIOPSY FORCEPS**  
**G-134**  
 Large Jaw 9.5" (24cm) Shaft

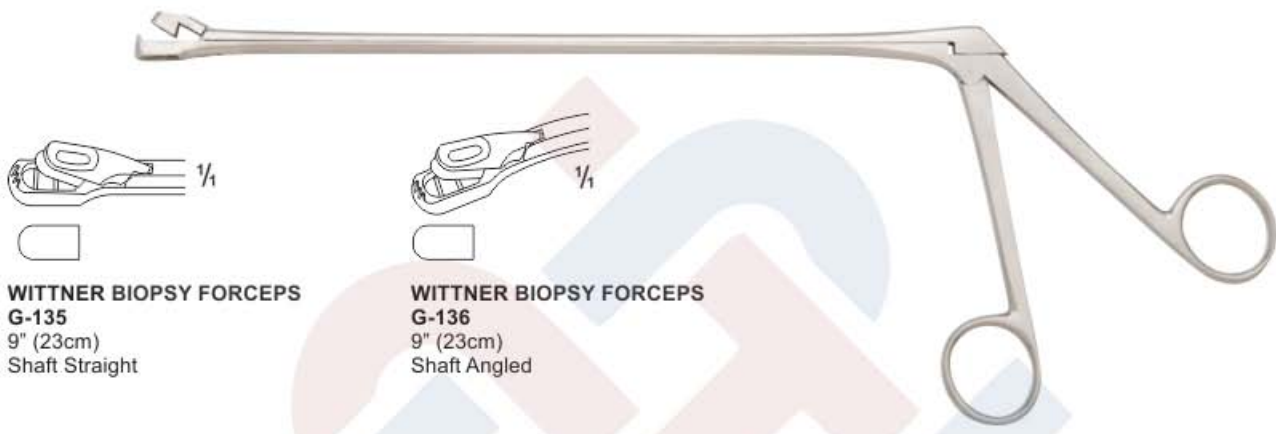

**WITNER BIOPSY FORCEPS**  
**G-135**  
 9" (23cm)  
 Shaft Straight

**WITNER BIOPSY FORCEPS**  
**G-136**  
 9" (23cm)  
 Shaft Angled



**TISCHLER BABY BIOPSY FORCEPS**  
**G-137**  
 8.5" (21.5cm) Shaft



**TISCHLER BIOPSY FORCEPS**  
**G-138**  
 8.5" (21.5cm) Shaft



# BIOPSY FORCEPS

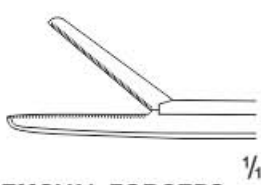

**IUCD REMOVAL FORCEPS**

**G-139**

8" (20CM)

Shaft Serrated Jaw



**SCHUMACHER BIOPSY FORCEPS**

**G-140** 9.5" (24cm)

Small Jaw Box Joint



1/4

**THOMS-GAYLOR BIOPSY FORCEPS**

**G-142** 8.75" (22cm)

Box Joint



1/4

**SCHUMACHER BIOPSY FORCEPS**

**G-141** 9.5"(2.4cm)

Large Jaw Box Joint

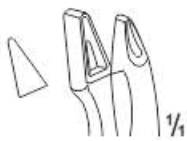

1/4

**VAN DORAN BIOPSY FORCEPS**

**G-143** 10.5" (27cm)

Box Joint

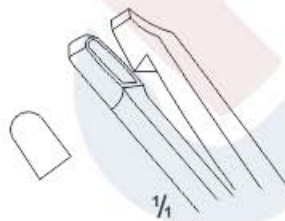

1/4

**SCHUBERT BIOPSY FORCEPS**

**G-144** 10.25" (20cm)

Box Joint



1/4

**FAURE BIOPSY FORCEPS**

**G-145**

9.5" (21.5cm)

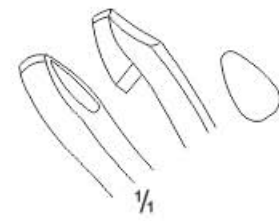

1/4

**FAURE BIOPSY FORCEPS**

**G-146**

8.25" (21.5cm)



# DILATORS



Many varieties of Dilators are available. Only showing in this catalogue the most popular European and North American designs.

- 0.5 °
- 1 °
- 2 °
- 3 °
- 4 °
- 5 °
- 6 °
- 7 °
- 8 °
- 9 °
- 10 °
- 11 °

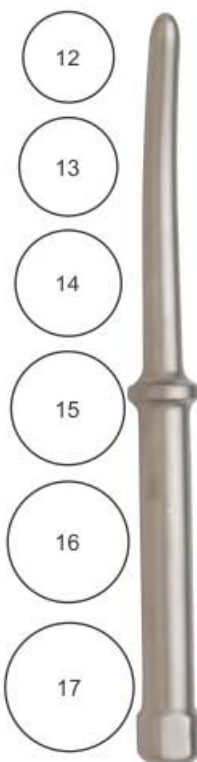

**BONNEY-BARKER DILATORS**

- G-147 7.25" (18.5cm) 3-4-5mm
- G-148 7.25" (18.5cm) 4-5-6mm
- G-149 7.25" (18.5cm) 5-6-7mm
- G-150 7.25" (18.5cm) 6-7-8mm
- G-151 7.25" (18.5cm) 7-8-9mm
- G-152 7.25" (18.5cm) 8-9-10mm
- G-153 7.25" (18.5cm) 9-10-11mm
- G-154 7.25" (18.5cm) 10-11-12mm
- G-155 7.25" (18.5cm) 11-12-13mm
- G-156 7.25" (18.5cm) 12-13-14mm
- G-157 7.25" (18.5cm) 13-14-15mm
- G-158 7.25" (18.5cm) 14-15-16mm
- G-159 7.25" (18.5cm) 15-16-17mm
- G-160 7.25" (18.5cm) 16-17-18mm
- G-161 7.25" (18.5cm) 17-18-19mm
- G-162 7.25" (18.5cm) 18-19-20mm
- G-163 Set-16 7.5" (19mm)
- G-164 Canvas Roll



**HANK DOUBLE ENDED**

- G-165 10.5" (27cm) 9/10mm
- G-166 10.5" (27cm) 11/12mm
- G-167 10.5" (27cm) 13/14mm
- G-168 10.5" (27cm) 15/16mm
- G-169 10.5" (27cm) 17/18mm
- G-170 10.5" (27cm) 19/20mm
- G-171 Set 6 D/e 9/10-19/20mm



**HAWKIN AMBLER DILATORS**

- G-172 6.75" (17cm) 3-6mm
- G-173 6.75" (17cm) 4-7mm
- G-174 6.75" (17cm) 5-8mm
- G-175 6.75" (17cm) 6-9mm
- G-176 6.75" (17cm) 7-10mm
- G-177 6.75" (17cm) 8-11mm
- G-178 6.75" (17cm) 9-12mm
- G-179 6.75" (17cm) 10-13mm
- G-180 6.75" (17cm) 11-14mm
- G-181 6.75" (17cm) 12-15mm
- G-182 6.75" (17cm) 13-16mm
- G-183 6.75" (17cm) 14-17mm
- G-184 6.75" (17cm) 15-18mm
- G-185 6.75" (17cm) 16-19mm
- G-186 6.75" (17cm) 17-20mm
- G-187 6.75" (17cm) 18-21mm
- G-188 Set of 16, 3/6-18/21mm
- G-189 Canvas Roll Only

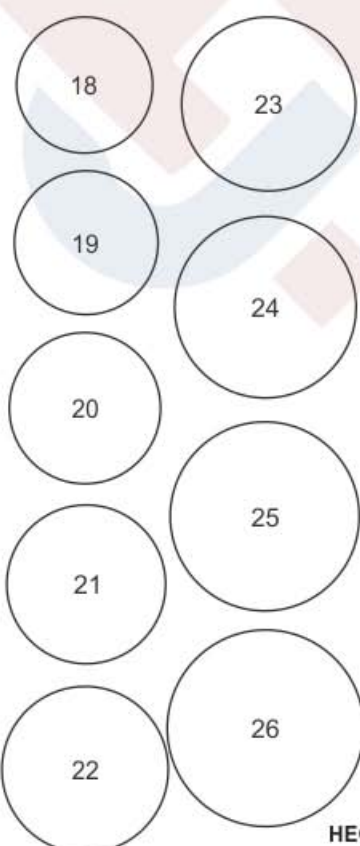

**HEGAR SINGLE ENDED**

- G-190 7.25" (18.5cm) 2mm
- G-191 7.25" (18.5cm) 3mm
- G-192 7.25" (18.5cm) 4mm
- G-193 7.25" (18.5cm) 5mm
- G-194 7.25" (18.5cm) 6mm
- G-195 7.25" (18.5cm) 7mm
- G-196 7.25" (18.5cm) 8mm
- G-197 7.25" (18.5cm) 9mm
- G-198 7.25" (18.5cm) 10mm
- G-199 7.25" (18.5cm) 11mm
- G-200 7.25" (18.5cm) 12mm
- G-201 7.25" (18.5cm) 13mm
- G-202 7.25" (18.5cm) 14mm
- G-203 7.25" (18.5cm) 15mm
- G-204 7.25" (18.5cm) 16mm
- G-205 7.25" (18.5cm) 17mm
- G-206 7.25" (18.5cm) 18mm
- G-207 7.25" (18.5cm) 19mm
- G-208 7.25" (18.5cm) 20mm
- G-209 7.25" (18.5cm) 21mm
- G-210 7.25" (18.5cm) 22mm
- G-211 7.25" (18.5cm) 23mm
- G-212 7.25" (18.5cm) 24mm
- G-213 7.25" (18.5cm) 25mm
- G-214 7.25" (18.5cm) 26mm
- G-215 Set of 12 S/E 3-14mm
- G-216 Set 12 S/E Canvas Only







## DILATORS



- G-217 8" (20cm) 1/2mm
- G-218 8" (20cm) 3/4mm
- G-219 8" (20cm) 5/6mm
- G-220 8" (20cm) 7/8mm
- G-221 8" (20cm) 9/10mm
- G-222 8" (20cm) 11/12mm
- G-223 8" (20cm) 13/14mm
- G-224 8" (20cm) 15/16mm
- G-225 8" (20cm) 17/18mm
- G-226 8" (20cm) 19/20mm
- G-227 8" (20cm) 21/22mm
- G-228 8" (20cm) 23/24mm
- G-229 8" (20cm) 25/26mm
- G-230 Set 8 Double Ended 3/4mm-17/18mm
- G-231 Set 12 Double Ended 1/2mm-23/24mm
- G-232 Set 8 Double Ended Canvas Only
- G-233 Set 12 Double Ended Canvas Only

**HEGAR DOUBLE ENDED DILATORS**



- G-234 11.5" (29cm) 13/15 FG
- G-235 11.5" (29cm) 17/19 FG
- G-236 11.5" (29cm) 21/23 FG
- G-237 11.5" (29cm) 25/27 FG
- G-238 11.5" (29cm) 29/31 FG
- G-239 11.5" (29cm) 33/35 FG
- G-240 11.5" (29cm) 37/39 FG
- G-241 11.5" (29cm) 41/43 FG
- G-242 Set 8 Double Ended 13/15-41/43 FG

As an ongoing process, all dilators are being made from stainless steel, some like the Hawkin Amblers are still supplied in electroplated versions. All dilators are available in set configurations. We have listed the most popular set combinations.

**PRATT DOUBLE ENDED DILATORS**



- |                |                |
|----------------|----------------|
| G-243 1.0mm Ø  | G-267 13.5mm Ø |
| G-244 1.5mm Ø  | G-268 14.0mm Ø |
| G-245 2.0mm Ø  | G-269 14.5mm Ø |
| G-246 2.5mm Ø  | G-270 15.0mm Ø |
| G-247 3.0mm Ø  | G-271 15.5mm Ø |
| G-248 3.5mm Ø  | G-272 16.0mm Ø |
| G-249 4.0mm Ø  | G-273 16.5mm Ø |
| G-250 4.5mm Ø  | G-274 17.0mm Ø |
| G-251 5.0mm Ø  | G-275 17.5mm Ø |
| G-252 6.0mm Ø  | G-276 18.0mm Ø |
| G-253 6.5mm Ø  | G-277 18.5mm Ø |
| G-254 7.0mm Ø  | G-278 19.0mm Ø |
| G-255 7.5mm Ø  | G-279 19.5mm Ø |
| G-256 8.0mm Ø  | G-280 20.0mm Ø |
| G-257 8.5mm Ø  | G-281 21.0mm Ø |
| G-258 9.0mm Ø  | G-282 22.0mm Ø |
| G-259 9.5mm Ø  | G-283 23.0mm Ø |
| G-260 10.0mm Ø | G-284 24.0mm Ø |
| G-261 10.5mm Ø | G-285 25.0mm Ø |
| G-262 11.0mm Ø | G-286 26.0mm Ø |
| G-263 11.5mm Ø | G-287 27.0mm Ø |
| G-264 12.0mm Ø | G-288 28.0mm Ø |
| G-265 12.5mm Ø | G-289 29.0mm Ø |
| G-266 13.0mm Ø | G-290 30.0mm Ø |

**Hegar Uterine Dilator single ended**



**Hegar Uterine Dilator single ended**  
**G-291 4 mm - 17 mm Ø**  
 8 Pieces per set  
**G-292 1 mm - 26 mm Ø**  
 24 Pieces per set



**Hegar Uterine Dilator single ended**  
**G-293 4 mm - 17 mm Ø**  
 24 pieces per set



**G-294**  
9.5" (24cm)  
Calibrated,  
With Lock

**KOGAN VULSELLUM FORCEPS**

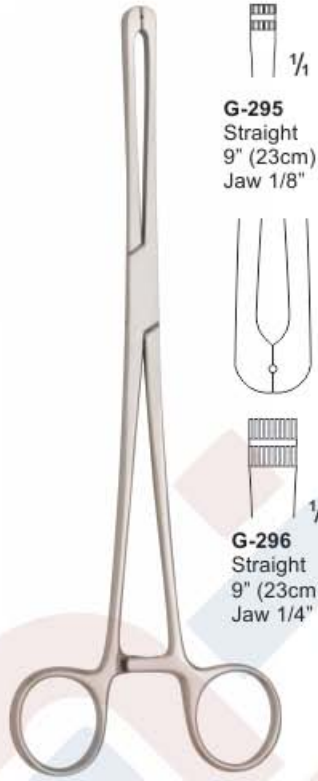

**G-295**  
Straight  
9" (23cm)  
Jaw 1/8"

**ATRAUMA VULSELLUM FORCEPS**



**ATRAUMA VULSELLUM FORCEPS**  
**G-297** 11.5" (29cm) 1/4"  
(0.5cm) Jaw + Sound

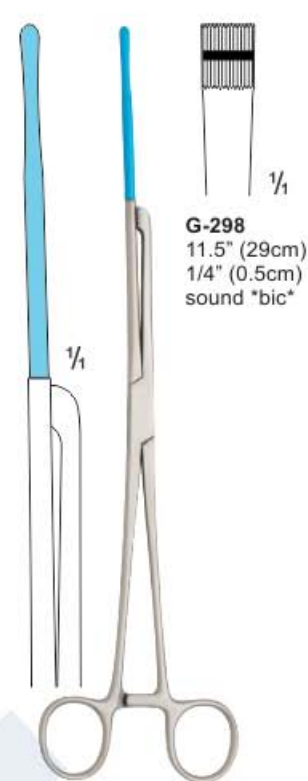

**G-298**  
11.5" (29cm)  
1/4" (0.5cm)  
sound "bic"

**ATRAUMA VULSELLUM FORCEPS**



**G-299**  
9" (23cm)  
1 X 12th "bic"

**CERVICAL DISSECTING FORCEP**

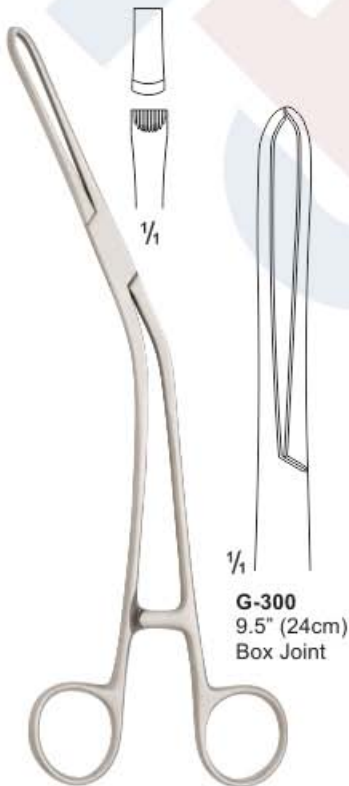

**G-300**  
9.5" (24cm)  
Box Joint

**Bierer Vulsellum Tenaculum Forceps Angled**

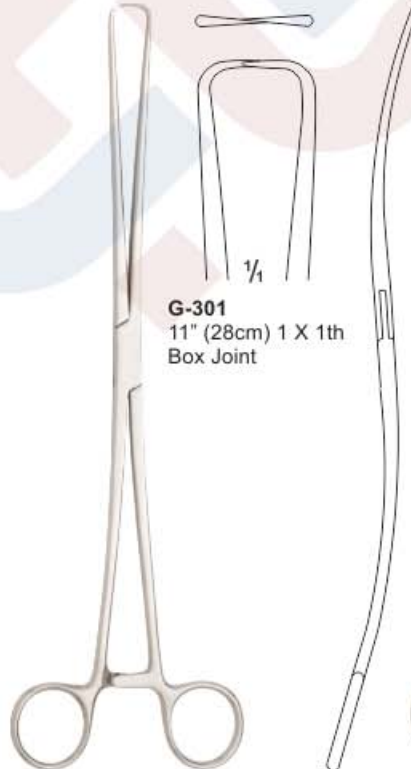

**G-301**  
11" (28cm) 1 X 1th  
Box Joint

**DUPLAY VULSELLUM FORCEPS**



**G-302**  
9.5" (24cm) 2 X 2th  
Box Joint

**LEWER VULSELLUM FORCEPS**  
(Also known as 'Museux')



# TENACULUM / VULSELLUM FORCEPS



**G-303**  
10" (25.5cm) 1 X 1  
Box Joint

**BRAUN VULSELLUM FORCEPS**



**G-304**  
9.5" (24cm) 1 X 1  
Box Joint

**LUER VULSELLUM FORCEP**



**G-305**  
9.5" (24cm) 1 X 1th Box  
Joint \*bic\*

**LUER VULSELLUM FORCEP**



**LUER VULSELLUM FORCEPS + SOUND**  
**G-306** 12" (30.5cm) Box Joint

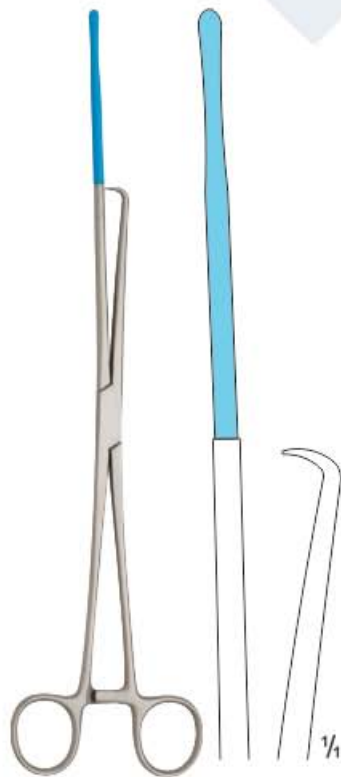

**LUER VULSELLUM FORCEPS + SOUND**  
**G-307** 12" (30.5cm)



**G-308**  
10.5" (27cm)  
1 X 1th

**ROTUNDA VULSELLUM FORCEPS**

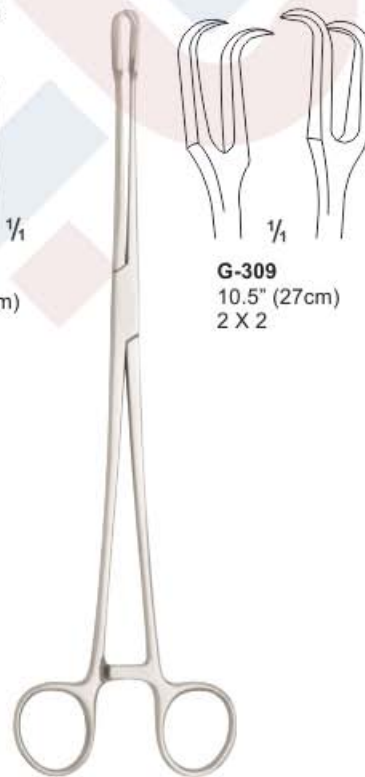

**G-309**  
10.5" (27cm)  
2 X 2

**SCHROEDER VULSELLUM FORCEP**



 1/4  
3 X 4th Box Joint  
**G-310** Straight  
10.5" (27cm)  
**G-311** Curved  
7" (18cm)  
**G-312** Curved  
9.5" (24cm)

**TEAL VULSELLUM FORCEPS**



RECAMIER



**G-313**  
No. 00, 5mm



**G-314**  
No. 0, 6mm



**G-315**  
No. 1, 7mm



**G-316**  
No. 2, 8mm



**G-317**  
No. 3, 9mm



**G-318**  
No. 4, 11mm



**G-319**  
No. 5, 12mm



**G-320**  
No. 6, 14mm



**G-321**  
No. 8, 16mm



**G-322**  
No. 13, 25mm



**G-323**  
No. 14, 30mm



**G-324**  
No. 15, 35mm



**G-325**  
No. 16, 40mm



**G-326**  
No. 9, 19mm

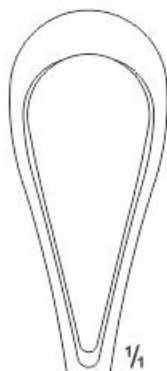

**G-327**  
No. 10, 20mm

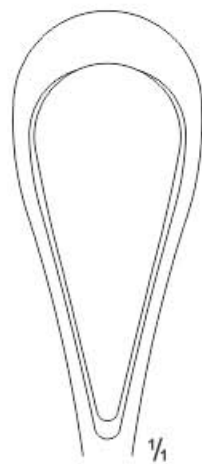

**G-328**  
No. 11, 21mm

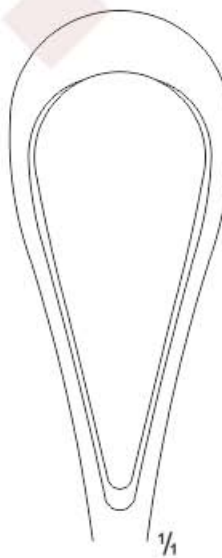

**G-329**  
No. 7, 15mm

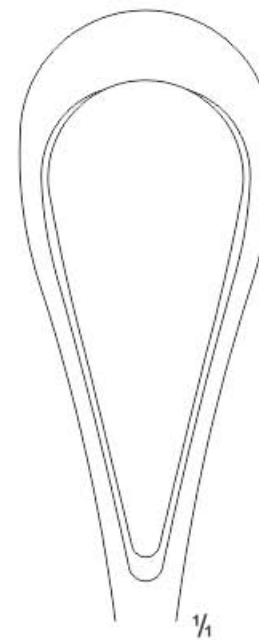

**G-330**  
No. 12, 23mm



RECAMIER

**RECAMIER RIGID**

- G-331 00 5MM SHARP 12.5" (32CM)
- G-332 0 6MM SHARP 12.5" (32CM)
- G-333 1 7MM SHARP 12.5" (32CM)
- G-334 2 8MM SHARP 12.5" (32CM)
- G-335 3 9MM SHARP 12.5" (32CM)
- G-336 4 11MM SHARP 12.5" (32CM)
- G-337 5 12MM SHARP 12.5" (32CM)
- G-338 6 14MM SHARP 12.5" (32CM)
- G-339 7 15MM SHARP 12.5" (32CM)
- G-340 8 16MM SHARP 12.5" (32CM)
- G-341 9 19MM SHARP 12.5" (32CM)
- G-342 10 20MM SHARP 12.5" (32CM)
- G-343 11 21MM SHARP 12.5" (32CM)
- G-344 12 23MM SHARP 12.5" (32CM)
- G-345 13 25MM SHARP 12.5" (32CM)
- G-346 14 30MM SHARP 12.5" (32CM)
- G-347 15 35MM SHARP 12.5" (32CM)
- G-348 16 40MM SHARP 12.5" (32CM)



**RECAMIER MALLEABLE**

- G-349 00 5MM SHARP 12.5" (32CM)
- G-350 0 6MM SHARP 12.5" (32CM)
- G-351 1 7MM SHARP 12.5" (32CM)
- G-352 2 8MM SHARP 12.5" (32CM)
- G-353 3 9MM SHARP 12.5" (32CM)
- G-354 4 11MM SHARP 12.5" (32CM)
- G-355 5 12MM SHARP 12.5" (32CM)
- G-356 6 14MM SHARP 12.5" (32CM)
- G-357 7 15MM SHARP 12.5" (32CM)
- G-358 8 16MM SHARP 12.5" (32CM)
- G-359 9 19MM SHARP 12.5" (32CM)
- G-360 10 20MM SHARP 12.5" (32CM)
- G-361 11 21MM SHARP 12.5" (32CM)
- G-362 12 23MM SHARP 12.5" (32CM)
- G-363 13 25MM SHARP 12.5" (32CM)
- G-364 14 30MM SHARP 12.5" (32CM)
- G-365 15 35MM SHARP 12.5" (32CM)
- G-366 16 40MM SHARP 12.5" (32CM)



RECAMIER

**RECAMIER RIGID**

- G-367 00 5mm Blunt 12.5" (32cm)
- G-368 0 6mm Blunt 12.5" (32cm)
- G-369 1 7mm Blunt 12.5" (32cm)
- G-370 2 8mm Blunt 12.5" (32cm)
- G-371 3 9mm Blunt 12.5" (32cm)
- G-372 4 11mm Blunt 12.5" (32cm)
- G-373 5 12mm Blunt 12.5" (32cm)
- G-374 6 14mm Blunt 12.5" (32cm)
- G-375 7 15mm Blunt 12.5" (32cm)
- G-376 8 16mm Blunt 12.5" (32cm)
- G-377 9 19mm Blunt 12.5" (32cm)
- G-378 10 20mm Blunt 12.5" (32cm)
- G-379 11 21mm Blunt 12.5" (32cm)
- G-380 12 23mm Blunt 12.5" (32cm)
- G-381 13 25mm Blunt 12.5" (32cm)
- G-382 14 30mm Blunt 12.5" (32cm)
- G-383 15 35mm Blunt 12.5" (32cm)
- G-384 16 40mm Blunt 12.5" (32cm)

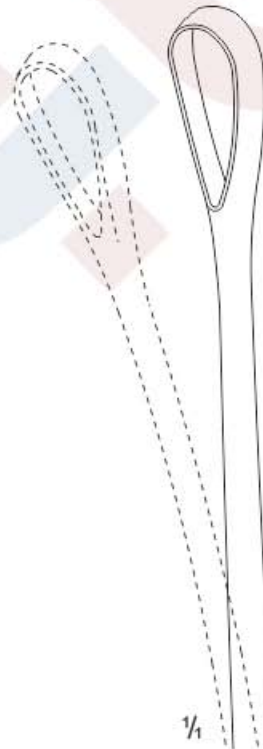

**RECAMIER MALLEABLE**

- G-385 00 5mm Blunt 12.5" (32cm)
- G-386 0 6mm Blunt 12.5" (32cm)
- G-387 1 7mm Blunt 12.5" (32cm)
- G-388 2 8mm Blunt 12.5" (32cm)
- G-389 3 9mm Blunt 12.5" (32cm)
- G-390 4 11mm Blunt 12.5" (32cm)
- G-391 5 12mm Blunt 12.5" (32cm)
- G-392 6 14mm Blunt 12.5" (32cm)
- G-393 7 15mm Blunt 12.5" (32cm)
- G-394 8 16mm Blunt 12.5" (32cm)
- G-395 9 19mm Blunt 12.5" (32cm)
- G-396 10 20mm Blunt 12.5" (32cm)
- G-397 11 21mm Blunt 12.5" (32cm)
- G-398 12 23mm Blunt 12.5" (32cm)
- G-399 13 25mm Blunt 12.5" (32cm)
- G-400 14 30mm Blunt 12.5" (32cm)
- G-401 15 35mm Blunt 12.5" (32cm)
- G-402 16 40mm Blunt 12.5" (32cm)



RECAMIER

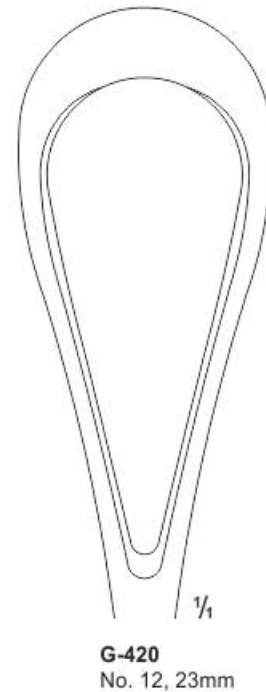
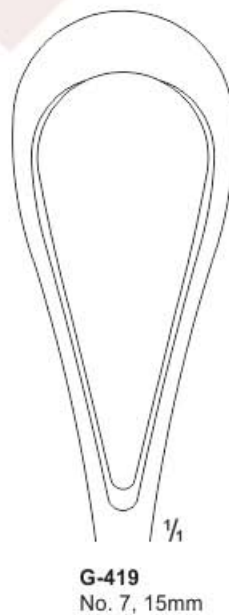
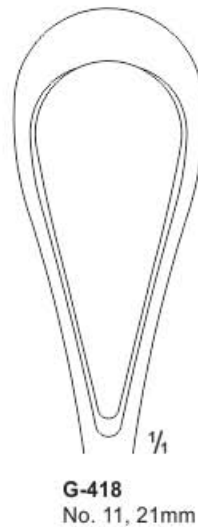
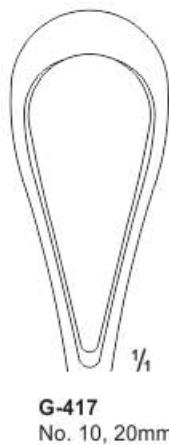
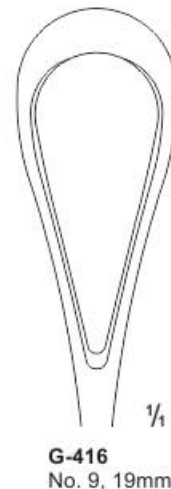
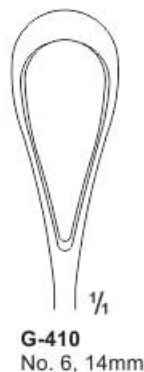
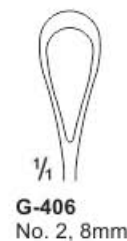
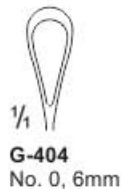



# UTERINE CURETTES



**SIMS  
SINGLE ENDED  
SHARP**

**G-421**  
Small 1/4" (6mm)  
Sharp 10" (25.5cm)



**G-424**  
Small 1/4" (6mm)  
Blunt 10" (25.5cm)



**G-422**  
3Medium 3/8" (9mm)  
Sharp 10" (25.5cm)



**G-425**  
Medium 3/8" (9mm)  
Blunt 10" (25.5cm)



**G-423**  
Large 1/2" (12mm)  
Sharp 10" (25.5cm)



**G-426**  
Large 1/2" (12mm)  
Blunt 10" (25.5cm)



**SIMS  
SINGLE ENDED  
BLUNT**

**G-427**  
Small (1/4" X 3/16")  
(6mm X 5mm) Sharp  
Sharp 10" (25.5cm)

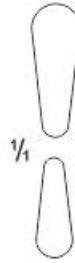

**G-428**  
Medium (3/8" X 1/4")  
(9mm X 6mm) Sharp  
Sharp 10" (25.5cm)

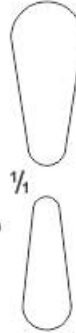

**G-429**  
Large (1/2" X 3/8")  
(12mm X 9mm) Sharp  
Sharp 10" (25.5cm)

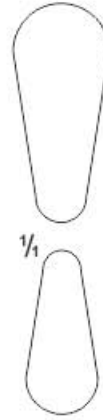

**KEVORKIAN  
ENDOCERVICAL  
CURETTES  
With Basket Square**

**G-430**  
12" (30.5cm)

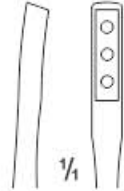

**KEVORKIAN  
ENDOCERVICAL  
CURETTES  
With Basket Round**

**G-431**  
12" (30.5cm)

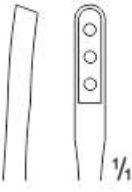

**KEVORKIAN  
ENDOCERVICAL  
CURETTES  
Without Basket Square**

**G-432**  
12" (30.5cm)

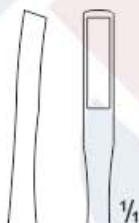

**SIMS  
DOUBLE ENDED  
S/S**

**G-433**  
Small (1/4" X 3/16")  
(6mm X 5mm) Sharp  
Blunt 10" (25.5mm)



**G-434**  
Medium (3/8" X 1/4")  
(9mm X 6mm) Sharp  
Blunt 10" (25.5mm)

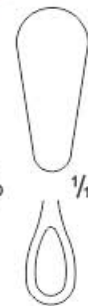

**G-435**  
Large (1/2" X 3/8")  
(12mm X 9mm) Sharp  
Blunt 10" (25.5mm)

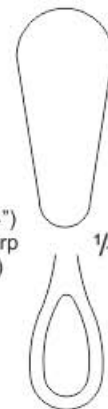

**SIMS  
DOUBLE ENDED  
SHARP BLUNT**

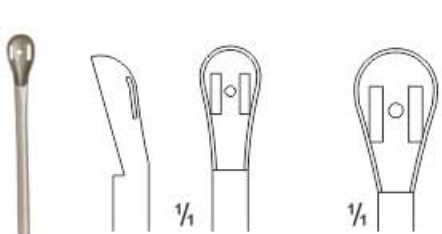

**G-436**  
Small 11.5" (29cm)  
5/16" (8mm) Sharp

**G-437**  
Medium 11.5" (29cm)  
7/16" (11mm) Sharp

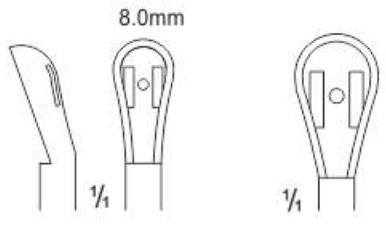

**G-439**  
Small 11.5" (29cm)  
5/16" (8mm) Blunt

**G-440**  
Medium 11.5" (29cm)  
7/16" (11mm) Blunt

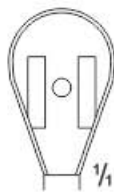

**G-438**  
Large 11.5" (29cm)  
9/16" (14mm) Sharp



**G-441**  
Large 11.5" (29cm)  
9/16" (14mm) Blunt



**G-442**  
12 FG 4mm  
10" (25.5cm)

**RHEINSTADTER  
FLUSHING CURETTES**

**RHEINSTADTER  
FLUSHING CURETTES**

**LEECHWILKINSON  
SUCTION BIOPSY CURETTES**

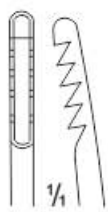

- 1 ● G-443
- 2 ● G-444
- 3 ● G-445
- 4 ● G-446

1mm 10" (25.5cm)  
2mm 10" (25.5cm)  
3mm 10" (25.5cm)  
4mm 10" (25.5cm)



- 2 ● G-447
- 3 ● G-448
- 4 ● G-449

2mm 10" (25.5cm)  
3mm 10" (25.5cm)  
4mm 10" (25.5cm)

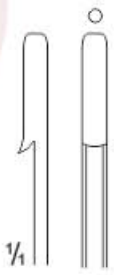

**G-450**  
10FG 9"  
(23cm) C/P

10FG 3.3mm



**NOVAK SUCTION  
BIOPSY CURETTES**



**RANDALL SUCTION  
BIOPSY CURETTES**



**SHARMAN ENDOMETRIAL  
BIOPSY CURETTES**





# DEPRESSORS, UTERUS HOLDING FORCEPS

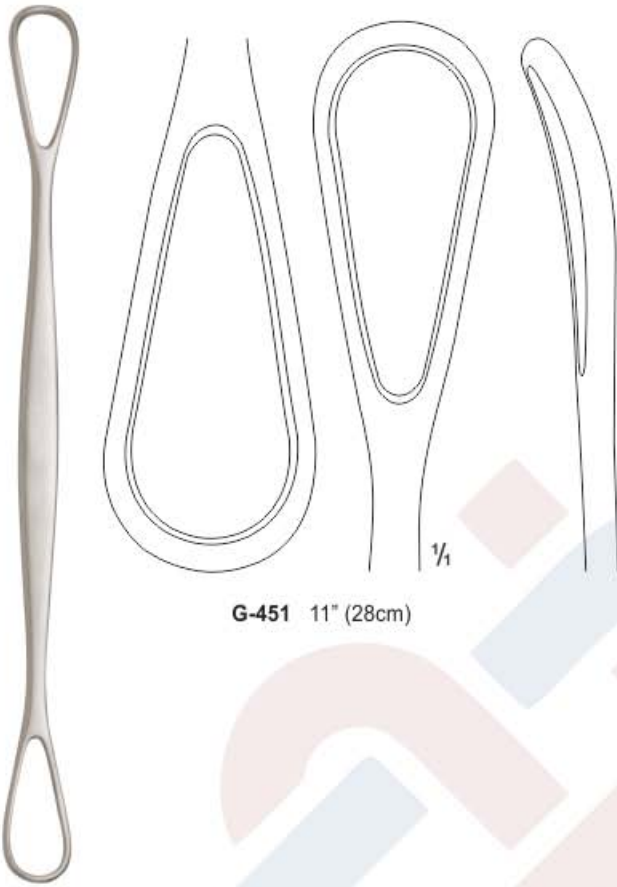

**G-451** 11" (28cm)

**BRAUN UTERINE DOUBLE ENDED**

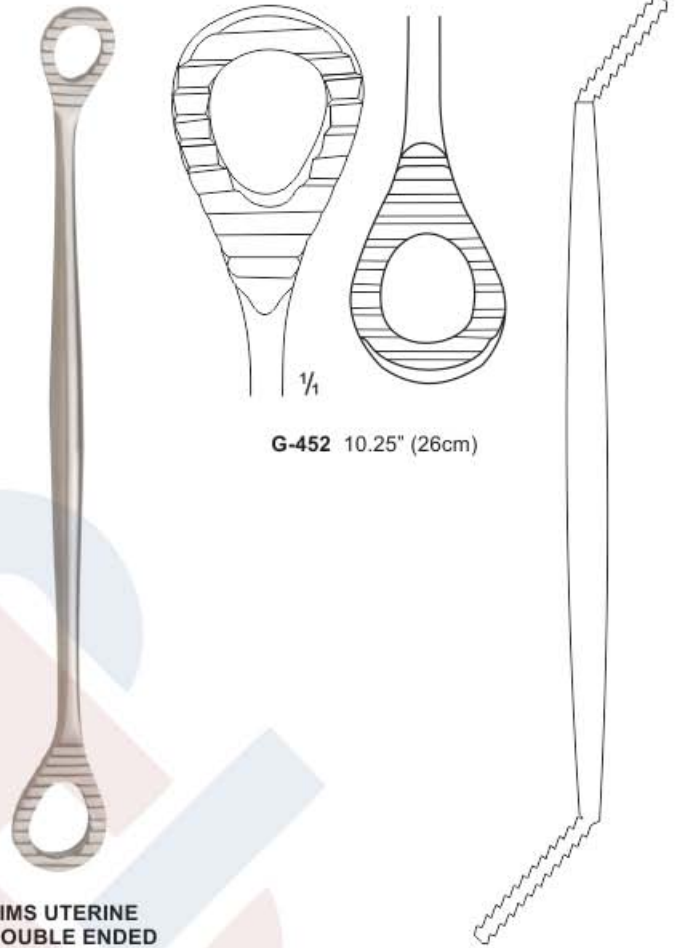

**G-452** 10.25" (26cm)

**SIMS UTERINE DOUBLE ENDED**

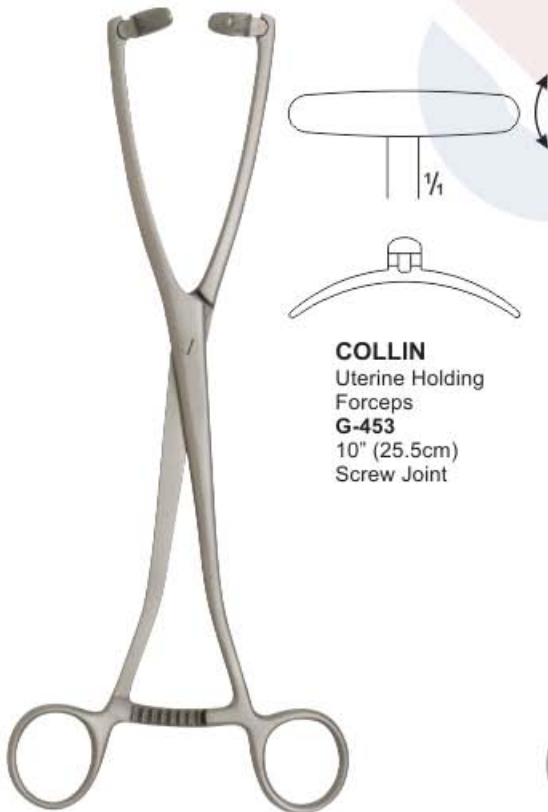

**COLLIN**  
Uterine Holding  
Forceps  
**G-453**  
10" (25.5cm)  
Screw Joint



**DARTIGUE**  
Uterine Holding  
Forceps  
**G-454**  
10.5" (27cm)  
Screw Joint

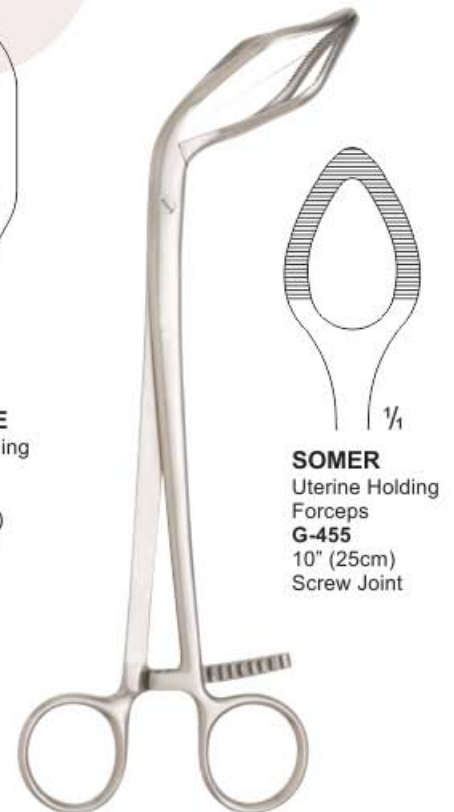

**SOMER**  
Uterine Holding  
Forceps  
**G-455**  
10" (25cm)  
Screw Joint

# UTERUS HOLDING FORCEPS



**G-456**  
8" (20cm)  
1 x 2th, Anguled  
Screw Joint

**BONNEY**



**G-457**  
8" (20cm)  
1 x 2th, Curved  
Screw Joint

**BONNEY-BERKLEY**

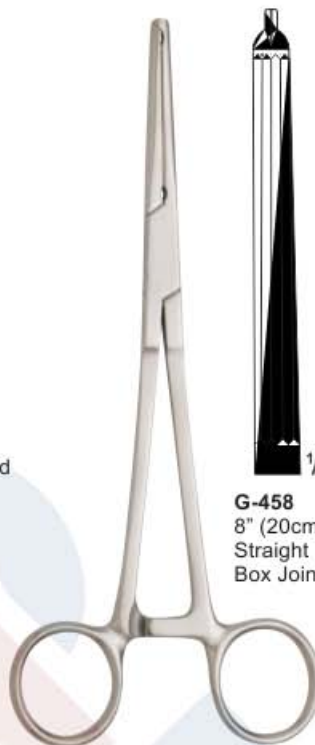

**G-458**  
8" (20cm)  
Straight  
Box Joint

**GWILLIAM**

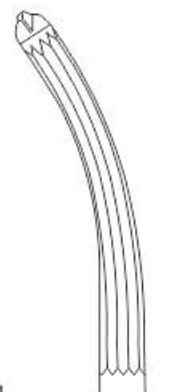

**G-459**  
8" (20cm)  
Curved  
Box Joint



**G-460**  
8" (20cm)  
Curved  
1 tooth  
Box Joint

**HEANEY**

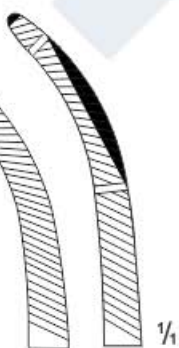

**G-461**  
8" (20cm)  
Curved  
2 Teeth  
Box Joint



**G-462**  
9" (23cm)  
Curved  
Box Joint

**HUNTER**



**G-463**  
8" (20cm)  
Straight  
Box Joint

**MAINGOT**



**G-464**  
8" (20cm)  
Curved  
Box Joint



**G-465**  
8.75" (22cm)  
Straight  
Box Joint

**McCULLAGH**



**G-466**  
9" (23cm)  
Curved  
Box Joint

**NAVRATILL**



**G-467**  
9" (23cm)  
Curved  
Box Joint

**WERTHEIM**



**G-468**  
10" (25.5cm)  
Curved  
Box Joint

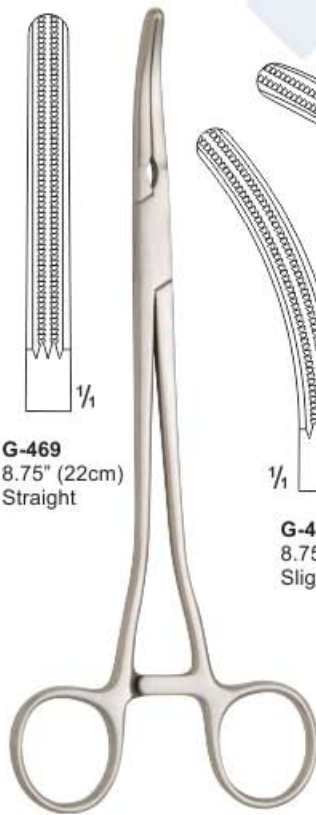

**G-469**  
8.75" (22cm)  
Straight

**PARAMETRIUM**

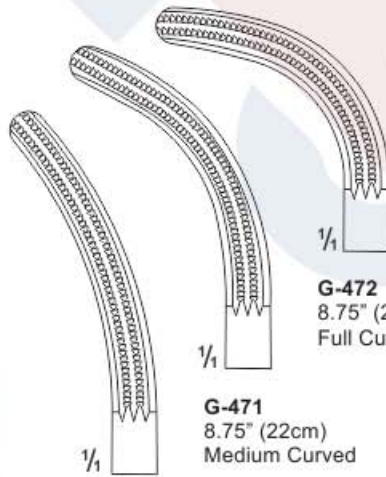

**G-470**  
8.75" (22cm)  
Slightly Curved

**G-471**  
8.75" (22cm)  
Medium Curved

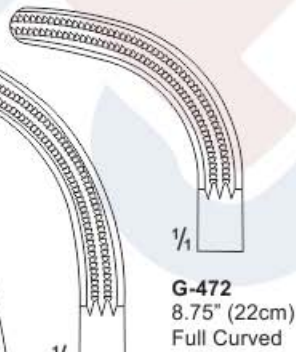

**G-472**  
8.75" (22cm)  
Full Curved

**BONNEY POLYPUS**



**G-473**  
9.5" (24cm)  
Box Joint

**KELLY POLYPUS**



**G-474**  
12.5" (32cm)  
Box Joint

**POLYPUS**



**G-475**  
10.5" (27cm)  
Narrow Screw  
Joint



**Doyen Myoma**  
for Abdomen  
**G-476**  
7" (18cm)  
Large



**Doyen Myoma**  
for Vagina  
**G-477**  
7" (18cm)  
Small



**BONNEY**  
**G-478**  
10.5" (27cm)  
Screw Joint



**LEECH WILKINSON**



**G-479**  
10" (25.5cm)  
Small C/P  
10mm



**G-480**  
10" (25.5cm)  
Medium C/P  
13mm



**G-481**  
10" (25.5cm)  
Large C/P  
16mm

**INSUFFLATION CANNULAS**



**CURRIE**  
Rubber Cone  
**G-472**  
14" (35.5cm)  
with Stopcock



**HAYES-PROVIS**  
**G-473**  
10" (25.5cm)  
10FG



**PROVIS**  
Rubber Cone  
**G-474**  
8" (20cm)  
10FG



**PROVIS**  
Metal Cone  
**G-475**  
7.75" (19.5cm)  
10FG



**SPACKMAN**  
Rubber Cone  
**G-476**  
14.75" (37.5cm)  
12FG



**SPACKMAN**  
Metal Cone

**G-477**  
14.75" (37.5cm)  
12FG 4 mm

**G-478**  
14.75" (37.5cm)  
18FG 6 mm



**SPACKMAN**  
Rubber Cone Only  
**G-479**  
Size:  
10FG & 12FG



**G-482**  
12" (30.5cm)  
Tip 4mm S/p

**GALABIN**



**G-483**  
11" (28cm)  
Tip 3mm S/p

**HORROCK**



**G-484**  
12" (30.5cm)  
Tip 4mm S/p

**SIMPSON**



**G-485**  
12.5" (32cm)  
Tip 4mm S/p

**SIMS**



**G-486**  
12.5" (32cm)  
Tip 5mm

**GRAFENBERG**



**G-487**  
8" (20cm)  
Straight  
Screw Joint

**GREEN-ARMYTAGE**



**G-488**  
7.75" (19.5cm)  
Angled  
Screw Joint

**GREEN-ARMYTAGE**



**G-489**  
13.75" (35cm)  
8EG 5mm, S/I

**DREWSMYTHE**



**G-490**  
10.25" (26cm)  
Box Joint

**GOODWIN**



**BRAUN**  
Cranioclast  
**G-491**  
16.5" (35cm)



**WINTER**  
Cranioclast  
**G-492**  
16.5" (35cm)



**BIERER**  
UTERUS EVACUATION /  
ASPIRATION CURETTES

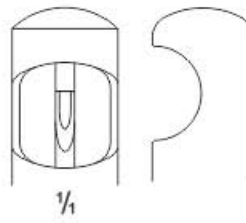

**G-493**  
11" (28cm)  
8mm

**G-494**  
11" (28cm)  
10mm

**G-495**  
11" (28cm)  
12mm

**G-496**  
11" (28cm)  
14mm

**G-497**  
11" (28cm)  
16mm



**CARTON**  
Mucous Evacuator  
**G-498**  
9" (23cm)

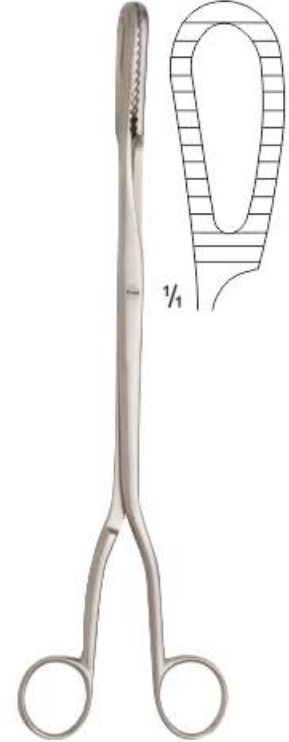

**BIERER**  
Ovum Forceps  
**G-499**  
11" (28cm), Screw joint

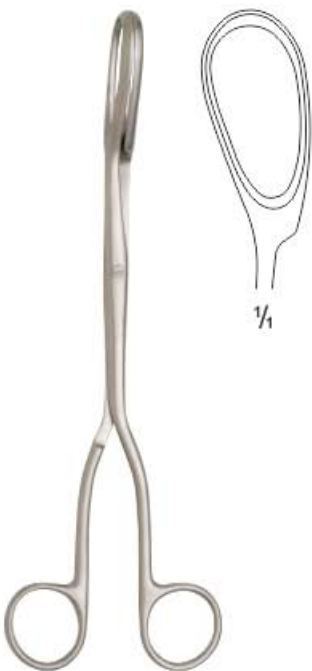

**GREENHALGH**  
Ovum Forceps  
**G-500**  
9.5" (24cm), Screw joint

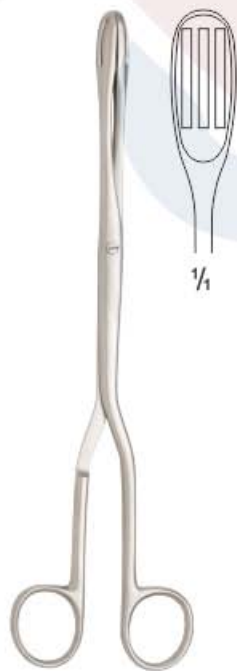

**HEYWOOD SMITH**  
Ovum Forceps  
**G-501**  
10.5" (27cm), Screw joint



**MCLINTOCK**  
Ovum Forceps  
**G-502** Curved  
9.5" (24cm), Screw joint

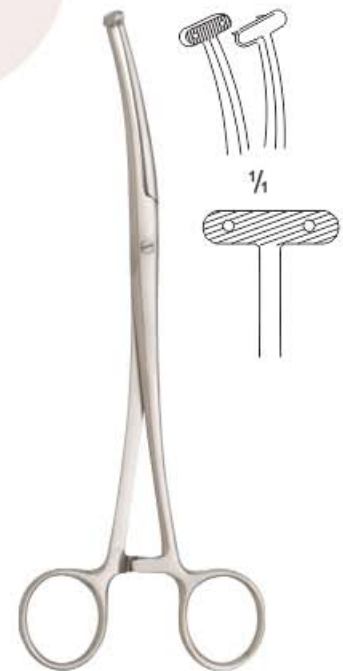

**WILLETT**  
Placenta Forceps  
**G-503** Curved  
7.5" (19cm), Screw joint





# OBSTETRIC FORCEPS



**ANDERSON**  
Midwifery Forceps  
**G-504**  
15" (38cm)



**BARNES**  
Neville Midwifery  
Forceps  
**G-505**  
15" (38cm)



**DE LEE**  
Midwifery Forceps  
**G-506**  
12" (30.5cm)



**HAIG**  
Ferguson  
Midwifery Forceps  
**G-507**  
14" (35.5cm)



**KIELLAND**  
Midwifery Forceps  
**G-508**  
16" (40.5cm)



**KIELLAND LUIKART**  
Midwifery Forceps  
**G-509**  
15.5" (39.5cm)



**MILNE MURRAY**  
Midwifery Forceps  
**G-510**  
13" (33cm)



**SIMPSON**  
Midwifery Forceps  
**G-511** 11" (28cm)  
**G-512** 15" (38cm)



**TARNIER**  
Midwifery Forceps  
**G-513**  
15.75" (40cm)



**WRIGLEY**  
Midwifery Forceps  
**G-514**  
11" (28cm)





**BREISKY**  
G-515  
13" (33cm)



**MARTIN**  
G-516  
13.5" (34.5cm)



**DENMAN**  
G-517 Screw Joint  
10.5" (25.5cm)



**SIMPSON**  
G-518 Screw Joint  
10.5" (25.5cm)



**UMBILICAL**  
G-519  
3.75" (9.5cm)



**PINARD**  
Stethoscopes  
G-520  
5" (13cm) Plastic Black



**PINARD**  
Stethoscopes  
G-531  
6" (15cm) Aluminium







DESCRIPTION	PAGE #
<b>A</b>	
American Umbilical Cord Scissors .....	01
Anderson Midwifery Forceps .....	30
Atrauma Vulsellum Forceps .....	17
Auvard Speculum .....	06
<b>B</b>	
Barnes Neville Midwifery Forceps .....	30
Bierer Ovum Forceps .....	29
Bierer Uterus Evacuation / Aspiration Curettes .....	29
Bierer Vulsellum Tenaculum Forceps .....	17
Bonney Hysterectomy Clamps .....	27
Bonney Polypus Forceps .....	26
Bonney Uterus Holding Forceps .....	25
Bonney Vaginal Clamps .....	05
Bonney-barker Dilators .....	15
Bonney-berkeley Uterus Holding Forceps .....	2
Bozeman Dressing Forceps .....	05
Braun Cranioclast .....	29
Braun Stadler Episiotomy Scissors .....	02
Braun Uterine Double Ended .....	24
Braun Vulsellum Forceps .....	18
Breisky Ovum .....	31
Burke Biopsy Forceps .....	12
Busch Umbilical Cord Scissors .....	01
<b>C</b>	
Carton Mucous Evacuator .....	29
Cervical Dissecting Forcep .....	17
Collin Speculum .....	06
Collin Uterine Holding Forceps .....	24
Comyn Berkeley Vulva Self Retaining .....	03
Currie Rubber Cone .....	27
Cusco Virgin Speculum .....	06-07
<b>D</b>	
Dartigue Uterine Holding Forceps .....	24
De Lee Midwifery Forceps .....	30
Denman Placenta Forceps .....	31
Doyen Myoma For Abdomen .....	27
Doyen Myoma For Vagina .....	27
Doyen Pozzi Retractor .....	03
Doyen Supra Hollow Handle .....	03
Doyen Vaginal Flat Retractor .....	03
Drewsmythe Iucid Uterine Hooks .....	28
Dubois Scissors .....	01
Duplay Vulsellum Forceps .....	17
<b>E</b>	
Eppendorf Biopsy Forceps .....	12
<b>F</b>	
Faure Biopsy Forceps .....	14
Female Bladder Sounds .....	05
Female Catherers .....	05
Fergusson Uterine Scissors .....	01
<b>G</b>	
Galabin Uterine Sounds .....	28
Gelpi Vulva Self Retaining .....	03
Goodwin Iucid Removal Forceps .....	28
Grafenberg .....	28
Graves (brewer) Virgin Speculum .....	07
Graves Vaginal Speculum Leep / Lietz .....	08
Graves Virgin Speculum .....	07
Graves Wide Virgin Speculum .....	07
Graves Wide Virgin Speculum .....	09
Green-armytage Iucid Removal Forceps .....	28
Greenhalgh Ovum Forceps .....	29
Gwilliam Uterus Holding Forceps .....	25
<b>H</b>	
Haig Ferguson Midwifery Forceps .....	30
Hank Double Ended .....	15
Hawkin Ambler Dilators .....	15
Hayes-provis .....	27
Heaney Uterus Holding Forceps .....	25
Hegar Double Ended Dilators .....	16
Hegar Single Ended .....	15
Hegar Uterine Dilator .....	16
Heywood Smith Ovum Forceps .....	29
Hormone Implant Trocar Set .....	05
Horrock Uterine Sounds .....	28
Hunter Uterus Holding Forceps .....	25
<b>I</b>	
Iris Skin Hooks .....	04
Iucid Removal Forceps .....	14
<b>J</b>	
Joll Thyroid Self Retaining .....	03
<b>K</b>	
Kelly Polypus Forceps .....	26
Kevorkian Endocervical Curettes .....	22

DESCRIPTION	PAGE #
Kevorkian Young Biopsy Forceps .....	12
Kielland Luikart Midwifery Forceps .....	30
Kielland Midwifery Forceps .....	30
Kogan Vulsellum Forceps .....	17
<b>L</b>	
Landon Vaginal Retractor .....	04
Lawson Tait Episiotomy Scissors .....	02
Leech Wilkinson Hysterectomy Clamps .....	27
Leechwilkinson Biopsy Forceps .....	12
Leechwilkinson Suction Biopsy Curettes .....	23
Leur Needle Extensions .....	05
Lewer Vulsellum Forceps .....	17
Luer Vulsellum Forceps + Sound .....	18
Luer Vulsellum Forceps .....	18
<b>M</b>	
Maingot Uterus Holding Forceps .....	25
Martin Ovum .....	31
Mccullagh Hysterectomy Clamps .....	26
Mclintock Ovum Forceps .....	29
Milne Murray Midwifery Forceps .....	30
<b>N</b>	
Navratill Hysterectomy Clamps .....	26
Novak Suction Biopsy Curettes .....	23
<b>P</b>	
Parametrium Hysterectomy Clamps .....	26
Pederson Vaginal Speculum Leep / Lietz .....	08
Pederson Virgin Speculum .....	08-09
Pinard Stethoscopes .....	31
Polypus Forceps .....	26
Pratt Double Ended Dilators .....	16
Provis Metal Cone .....	27
Provis Rubber Cone .....	27
<b>R</b>	
Randall Suction Biopsy Curettes .....	23
Recamier Uterine Curettes .....	19-21
Rheinstadter Flushing Curettes .....	23
Rotunda Catherers .....	05
Rotunda Vulsellum Forceps .....	18
<b>S</b>	
Schroeder Vulsellum Forcep .....	18
Schubert Biopsy Forceps .....	14
Schumacher Biopsy Forceps .....	13-14
Sharman Endometrial Biopsy Curettes .....	23
Simpson Midwifery Forceps .....	30
Simpson Placenta Forceps .....	31
Simpson Uterine Sounds .....	28
Sims Double Ended S/s .....	22
Sims Double Ended Sharp Blunt .....	22
Sims Single Ended Blunt .....	22
Sims Single Ended Sharp .....	22
Sims Uterine Double Ended .....	24
Sims Uterine Scissors .....	02
Sims Uterine Sounds .....	28
Sims Virgin Speculum .....	10
Somer Uterine Holding Forceps .....	24
Spackman Metal Cone .....	27
Spackman Rubber Cone .....	27
Spackman Rubber Only .....	27
<b>T</b>	
Tarnier Midwifery Forceps .....	30
Teal Vulsellum Forceps .....	18
Tenaculum 3 Prong Skin Hooks .....	04
Tenaculum Emmet Skin Hooks .....	04
Thoms-gaylor Biopsy Forceps .....	14
Tischler Baby Biopsy Forceps .....	13
Tischler Biopsy Forceps .....	13
<b>U</b>	
Umbilical Umbilical Dilators .....	31
Uterine Scissors .....	02
<b>V</b>	
Vaginal Dressing Forceps .....	05
Vaginal Lateral Wall Retractor .....	11
Van Doran Biopsy Forceps .....	14
<b>W</b>	
Weisman Graves Virgin Speculum .....	09
Weisman Virgin Speculum .....	08
Wertheim Hysterectomy Clamps .....	26
Wertheim Retractor .....	04
Whittaker Skin Hooks .....	04
Willett Placenta Forceps .....	29
Winter Cranioclast .....	29
Winterton Vaginal Speculum .....	10
Wittner Biopsy Forceps .....	13
Wrigley Midwifery Forceps .....	30



# Elektro

G E N E S I S

No 1/24 Stebondale Street, London,  
United Kingdom

☎ +44 7552016275

✉ info@elektrogenesis.com

Web: [www.elektrogenesis.com](http://www.elektrogenesis.com)

**Distributed by** Electro Genesis ME LLC  
D9 District 2 Jumeirah park  
Dubai UAEPO BOX 691403